

# DobyGrip Suspension System

## Applications - Electrical

Supports for Basket, Ladder & Tray



- Reduced Health & Safety risk on site.
- Technical Support for installation and product selection.
- Lower Environmental impact than traditional methods.
- Installation times reduced by up to 60% compared to traditional methods.
- Independently Tested, with 5:1 Safety Factor.
- Full range of accessories.
- Greater flexibility with the use of a wide range of accessories and ability to work at angles\*

\* non-vertical applications refer to safety instructions for installation methods and SWL.

### Suspension examples

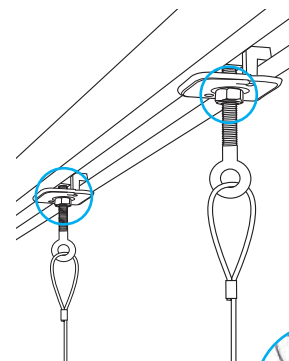
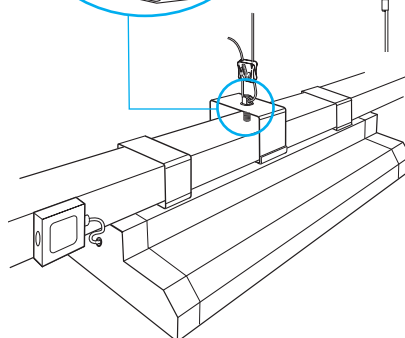
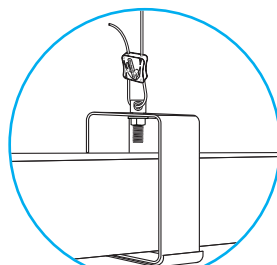
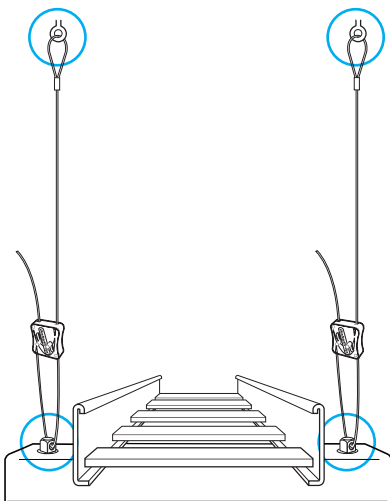
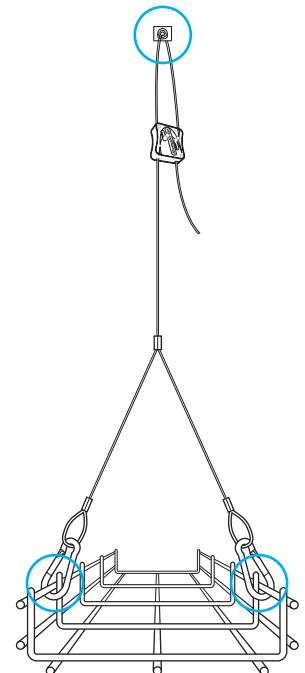
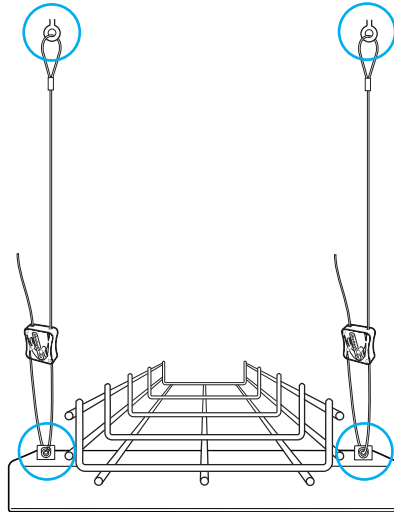

Alternative fixings are available depending on suspension point.



Applications



## The Dobygrip Family

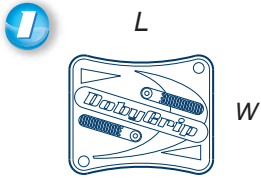

### DobyGrip 1

Width: 16.5mm (21/32")  
 Length: 20mm (25/32")  
 Height: 6mm (15/64")  
 Weight: 9gms (0.32oz)  
 Order code: DG1  
 Packing details: 50 per pkt.

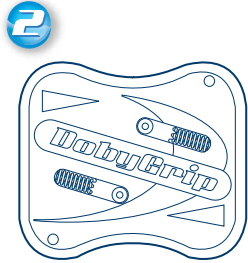

### DobyGrip 2

Width: 26mm (1 1/32")  
 Length: 30mm (1 3/16")  
 Height: 9mm (11/32")  
 Weight: 28gms (0.99oz)  
 Order code: DG2  
 Packing details: 20 per pkt.

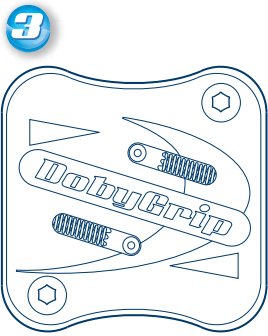

### DobyGrip 3

Width: 35mm (1 3/8")  
 Length: 35mm (1 3/8")  
 Height: 12mm (15/32")  
 Weight: 75gms (2.65oz)  
 Order code: DG3  
 Packing details: 10 per pkt.

## Technical details

### Loading Tables

	Wire Diameter	kg	lb
DobyGrip DG1	1mm (3/64") (7x7)	10	22
DobyGrip DG2	2mm (5/64") (7x7)	50	110
DobyGrip DG3	3mm (1/8") (7x7)	100	220

Load rating is covered by 5:1 safety factor & based upon a vertically applied load

The DobyGrip units will effectively work at other angles but the load capacity is reduced as stated to the right. Please refer to sales office for configurations outside of the tables.

Max.

Angle from Vertical	0 deg.	15 deg.	30 deg.	45 deg.	60 deg.
% of Loading (SWL)	100	90	80	70	50
DobyGrip DG1 Kg	10	9	8	7	5
DobyGrip DG2 Kg	50	45	40	35	25
DobyGrip DG3 Kg	100	90	80	70	50
DobyGrip DG1 lb	22	21	18	15	11
DobyGrip DG2 lb	110	99	88	77	55
DobyGrip DG3 lb	220	198	176	154	110

All ratings above were determined with independent testing by Northumbria University and witnessed by Lloyds Register. Life Cycle Test - Undertaken by Northumbria University, both the DG2 and DG3 were subjected to the load over a 300 hour period. Seismic testing was undertaken by Northumbria University and witnessed by Lloyds Register 110,000 cycles at 10Hz.

To further support the certification of the DobyGrip Suspension System, DobyGrip Sizes 1, 2, & 3 have now been witness tested by TÜV Rheinland AG a global provider of technical, safety and certification services with headquarters in Cologne, Germany.

The SMACNA Testing & Research Institute (STRI), the Sheet Metal and Air Conditioning Contractors' National Association (SMACNA) test house based in Virginia USA have verified that the DobyGrip Wire Suspension System DG1, DG2 & DG3 as an acceptable alternative to the duct hanger systems as prescribed in the USA HVAC Duct Construction Standards (HVAC-DCS), 3rd edition.

## Accessories



**Wire with Loop End Kit** - Galvanised steel (7x7strands), available in 3 diameters and 5 cut lengths, also supplied on a 150m reel for greater flexibility.



**Wire with Eye Bolt Kit** - Wire loop with either a closed M6 or M8 bolt. Quick fitting for concrete, ceilings and decking. Available in 5 cut wire lengths.



**Wire with Carabina Kit** - Quick answer for fixing to hooks, eyes, baskets, trays and slotted channel. Comes in 3 diameters and 5 cut wire lengths.



**Wire with Nail Anchor FNA II-OE** - Hammer set anchor for fixing into cracked & non-cracked concrete, solid sand lime brick, natural stone, prestressed hollow-core concrete slabs.



**M6/M8 Adaptor** - Designed to fit either a 6mm or 8mm dia. hole. Perfect for suspending cable trays, light fittings, hanging brackets etc. Use with DG1, 2 & 3.



**Spring Clip** - For suspending a variety of products and services when used with the DobyGrip. Made from 304 Stainless Steel, supplied in 2mm dia.



**Slide Nuts** - Ready to use pre-assembled for a quick fixing and retains assembly in place before final tightening. Complete with washer and retaining spring.



**Vertical Flange Clip** - Perfect fixing to vertical flanges. Vertical fixing hole is 6.5mm dia. To fix to S-hook, bolt/nut etc. Made from Spring steel (type CS70).



**Wire on Reels** - 150m of galvanised wire on a strong plastic reel. Wire is 7x7 strands and follows a strict quality inspection to ensure reliability.



**Y-Fitting Plain & Loop Ends** - Made to customers specifications of wire leg lengths. Available in 1, 2 & 3mm wire diameters. Standard held stock of 2mm x 3m with two leg lengths.



**Polyurethane sleeve for wire** - Protective sleeve for exposed static wires. Available in 4mm dia. Supplied on a 200m reel. Gives an attractive finish to wire.



**Wire Rope Cutters** - Hardened steel blades for accuracy / durability. Sprung loaded blades for ease with 13cm handles for leverage 4.75mm cut capacity.



Harelaw Industrial Estate, Stanley, Co. Durham DH9 8UJ

Tel: +44 (0)1207 238844, Fax: +44 (0)1207 283563,

E-mail: enq@dobyverrolec.com or visit [www.dobyverrolec.com](http://www.dobyverrolec.com), [www.dobygrip.com](http://www.dobygrip.com) & [www.dobysolutions.com](http://www.dobysolutions.com)